

Size	25mm ID
Part Number	OAVTB60i25
Housing Material/Finish	7075 Aircraft Quality Aluminum
Input Pressure	60 psi - 100 max psi
Porous Material	Carbon
Pressure Port Threads	M5 X 0.8
Lifetime	infinite
Radial Load Capacity	68.6 lbs (305.1 N)
Thrust Load Capacity	68.1 lbs (302.9N)
Radial Stiffness	0.19 lbs/μ in (34 N/μ m)
Pitch Moment Max	17 lbs-in (1.9 N-m)
Bushing Inside Diameter (ID)	25.018mm +.005mm -.000mm
Bushing Outside Diameter (OD)	59.59mm +.13mm -.00mm
Bushing Length	79.20mm
Bushing Weight	416.9g
Recommended Shaft Outside Diameter (OD)	25mm - .02mm

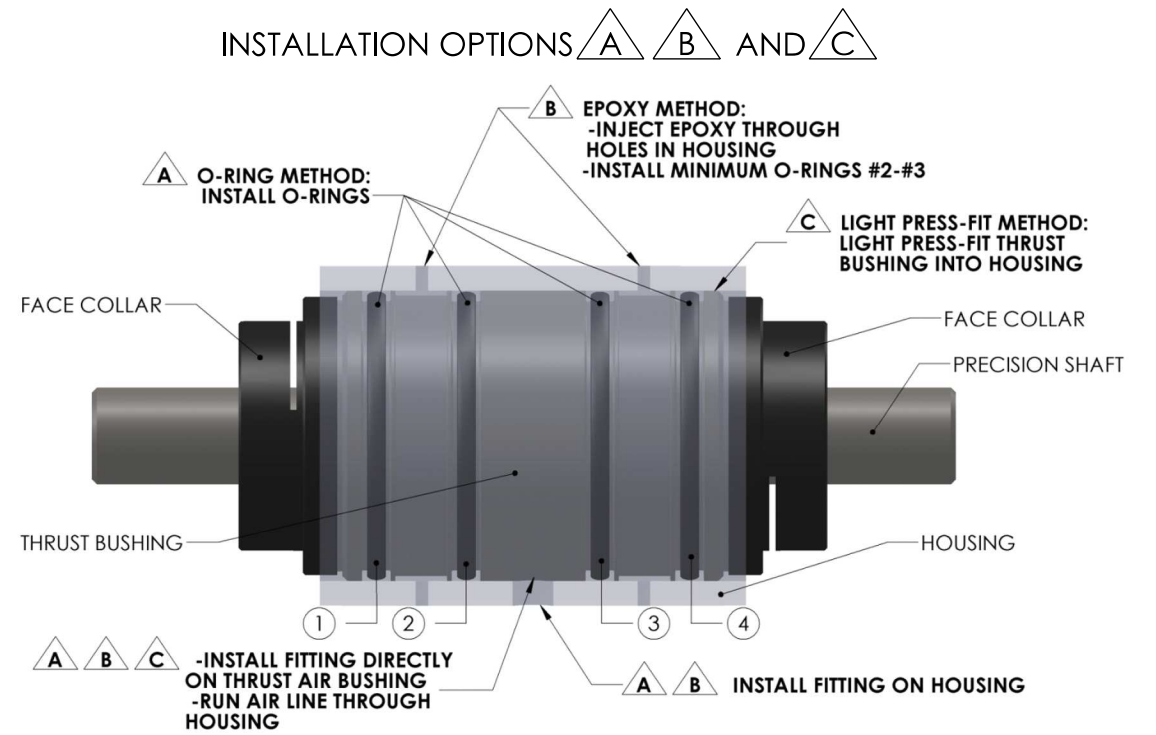
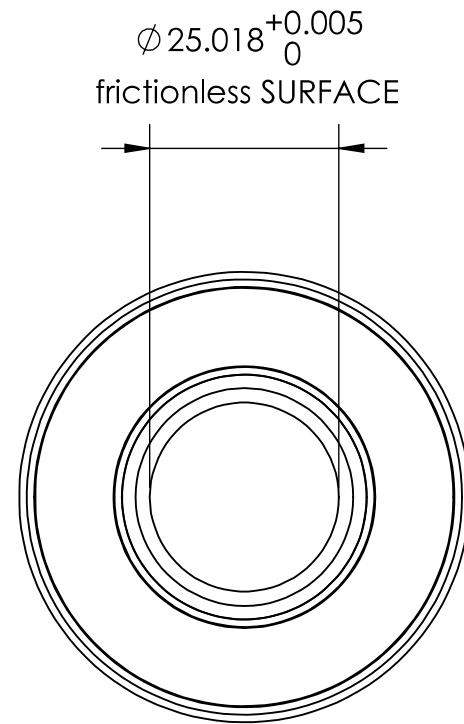
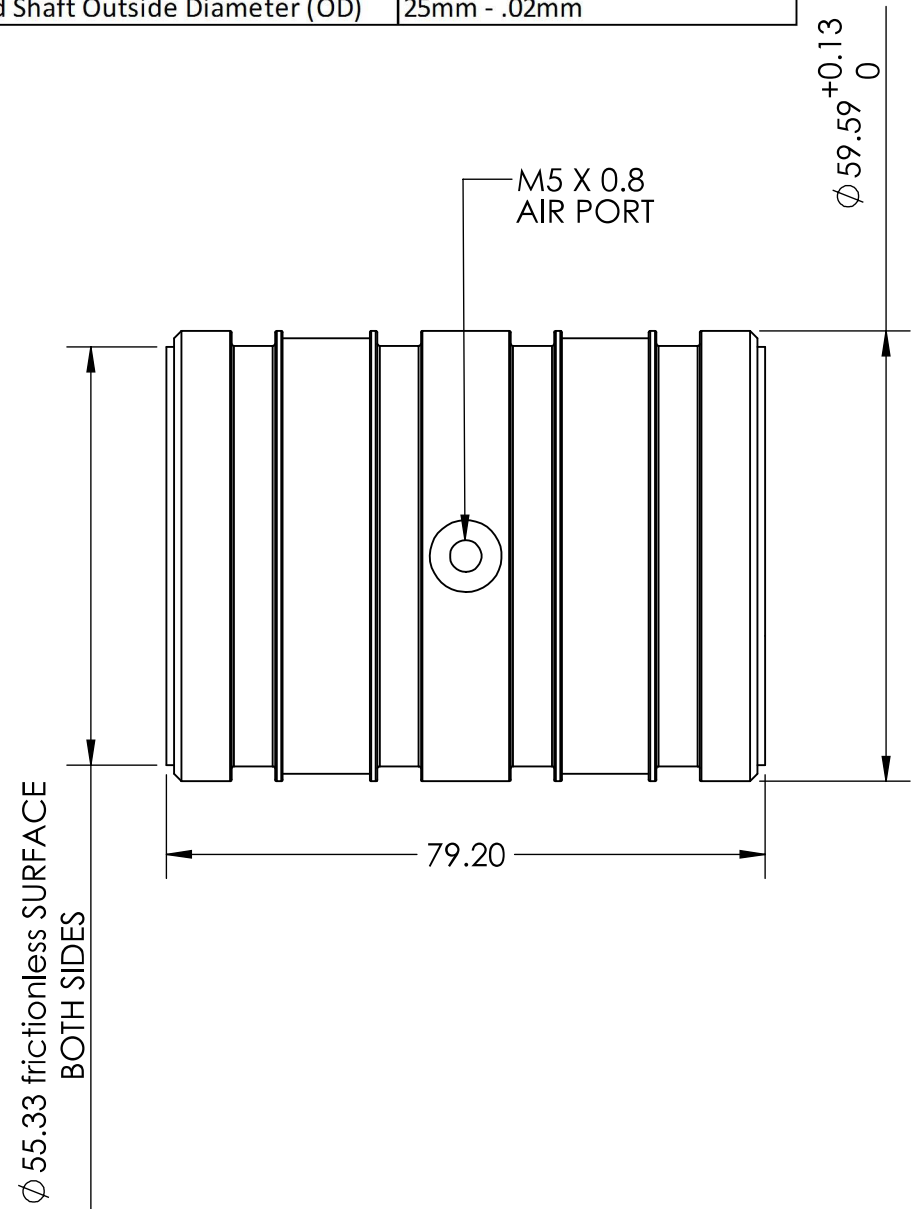

KRACHT

PROPRIETARY AND CONFIDENTIAL
 THE INFORMATION CONTAINED IN THIS DRAWING IS THE SOLE PROPERTY OF OAVCO LLC. ANY REPRODUCTION IN PART OR AS A WHOLE WITHOUT THE WRITTEN PERMISSION OF OAVCO LLC IS PROHIBITED.

UNLESS OTHERWISE SPECIFIED:		NAME	DATE
DIMENSIONS ARE IN MILLIMETERS		DRAWN	
TOLERANCES:		CHECKED	
FRACTIONAL ±		ENG APPR.	
ANGULAR: MACH ± BEND ±		MFG APPR.	
TWO PLACE DECIMAL ±		Q.A.	
THREE PLACE DECIMAL ±		COMMENTS:	
INTERPRET GEOMETRIC TOLERANCING PER:			
MATERIAL			
FINISH			
NEXT ASSY	USED ON		
APPLICATION		DO NOT SCALE DRAWING	

TITLE: 25MM 3-WAY THRUST BUSHING		
SIZE B	DWG. NO. OAVTB60i25	REV
SCALE: 1:1	WEIGHT:	SHEET 1 OF 1